

INSD02PTZIR25X

2.1MP Starlight IR PTZ 25x with SD slot

- 1/2.8" 2 Megapixel STARVIS™ CMOS
- Powerful 25x optical zoom
- Maximum 50/60 fps at 1080P
- PoE+
- Intelligent functions such as Auto-tracking, area protector and face detection

Unify your Security Solution

Starlight Technology Improve your levels of security by using our Starlight technology. With its optical features, Starlight Technology will be able to balance all lighting throughout a scene. This will capture any colored details regardless of the lighting.

Smart H.265+ & H.264+

STORM smart encoding technology can provide high-quality video with higher efficiency and can also reduce the cost of storage space and transmission adopting an advanced algorithm of auto stream control.

On-board Analytics

This camera responds accurately to specific events in a given area. Our algorithm enables Tripwire violations, intrusion detection, abandoned/missing objects and much more. Facilitate your viewing experience using on the edge analytics – one product, multiple features.



*Design and specifications are subjects to change without notice.

INSD02PTZIR25X

Product Specifications

2.1MP Starlight IR PTZ 25x with SD slot

Camera				
Image Sensor	1/2.8" 2 Megapixel STARVIS™ CMOS			
Effective Pixels	1920(H) x 1080(V)			
RAM/ROM	1024MB / 128MB			
Scanning System	Progressive			
Electronic Shutter Speed	1/1s ~ 1/30,000s			
Minimum Illumination	Color: 0.005 Lux at F1.6 (30IRE); B/W: 0.0005 Lux at F1.6 (30IRE); 0 Lux at F1.6 (IR on)			
S/N Ratio	More than 55 dB			
IR Distance	Distance up to 200m (656ft)			
IR LEDs	6			
Camera Features				
Day/Night	Auto(ICR) / Color / B/W			
Blacklight Compensation	BLC / HLC / WDR(120dB)			
White Balance	Auto, ATW, Indoor, Outdoor, Manual			
Gain Control	Auto/Manual			
Noise Reduction	Ultra DNR (2D / 3D)			
Digital Zoom	16x			
Motion Detection	Supported			
Region of Interest	Supported			
Privacy Masking	Up to 24 areas			
Image Stabilization	Supported			
Defog	Supported			
Flip	180°			
Lens				
Focal Length	4.8 mm – 120 mm			
Max. Aperture	F1.6 – F4.4			
Viewing Angle	H: 62.8° ~ 2.6°			
Optical Zoom	25x			
Focus Control	Auto / Manual			
Pan/Tilt/Rotation	Pan: 0° ~ 360° endless; Tilt: -20° ~ 90°; Auto flip: 180°			
DORI Distance	Detect	Observe	Recognize	Identify
	1613m (5292ft)	646m (2119ft)	323m (1060ft)	161m (528ft)
Video				
Compression	H.265+ / H.265 / H.264+ / H.264 / MJPEG			
Resolution	1080P (1920×1080) / 720P (1280×720) / D1(704×576/704×480) / CIF (352×288/352×240)			
Frame Rate	Main stream: 1080P / 1.3MP / 720P (1 to 50/60 fps)			
	Sub Stream: D1/CIF (1 to 25/30 fps)		Third Stream: 720P (1 to 25/30 fps)	
Bit Rate	H.264: 448K - 8192Kbps H.265: 448K - 8192Kbps			
Audio				
Compression	G.711a / G.711Mu / AAC / G.722 / G.726 / G.729 / MPEG2-L2			
Intelligent Functions				
Auto Tracking	Supported			
Smart Functions	Tripwire, Intrusion, Abandoned/Missing object, Face detection, Heatmap			
Event Trigger	Motion detection, Video tampering, Scene changing and more			

*Design and specifications are subjects to change without notice.



INSD02PTZIR25X

Product Specifications

2.1MP Starlight IR PTZ 25x with SD slot

PTZ	
Manual Control Speed	Pan: 0.1° ~ 200° /s; Tilt: 0.1° ~ 120° /s
Preset Speed	Pan: 300° /s; Tilt: 200° /s
Presets	300
PTZ Mode	5 Pattern, 8 Tour, Auto Pan, Auto Scan
Speed Setup	Human-oriented focal Length / speed adaptation
Power up Action	Auto restore to previous PTZ and lens status after power failure
Idle Motion	Activate Preset / Scan / Tour / Pattern if there is no command in the specified period
Lite AI	
Event Trigger	Motion detection, video tampering, scene changing, Network disconnection, IP address conflict, illegal access, and storage anomaly.
Smart Detection	Abandoned, missing Object
Smart Snapshot	Supports human and vehicle snapshots.
Area Protector	Tripwire and intrusion. Support alarm triggering by target types (human and vehicle). Supports filtering false alarms caused by animals, rustling leaves, bright lights, etc
Face Detection	Supported
Auto Tracking	Supported
Smart motion Detection	Supported
Network	
Ethernet	RJ-45 (10Base-T/100Base-TX)
Protocol	IPv4/IPv6, HTTP, HTTPS, SSL, TCP/IP, UDP, UPnP, ICMP, IGMP, SNMP, RTSP, RTP, SMTP, NTP, DHCP, DNS, PPPOE, DDNS, FTP, IP Filter, QoS, Bonjour, 802.1x
Compatibility	ONVIF Profile S&G, API
Video Software Management	STORM, STORM+, Arkiv
Maximum User Access	20 Users
Storage	NAS; Micro SD card up to 256GB
Smart Phone	iOS, Android
Interface	
Video	1 port (BNC, 1.0V[p-p], 75Ω)
RS485	1 (Line out)
Audio In/Out	1/1
Alarm In/Out	7/2
General	
Power Supply	AC24V/3A (±25%), PoE+ (802.3at)
Power Consumption	Less than 25W
Working Environment	-40°C to 70°C (-40°F ~ +158°F); Less than 95% RH
Vandal Resistance & IP	IK10; IP67
Weight	9.92 lbs (4.5kg)
Dimensions	Φ186 mm x 253 mm (Φ7.32" x 9.96")

*Design and specifications are subjects to change without notice.





INSD02PTZIR25X

Product Specifications

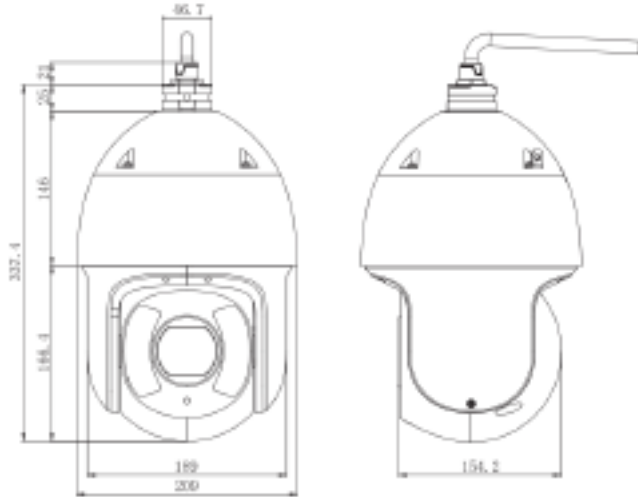
2.1MP Starlight IR PTZ 25x with SD slot

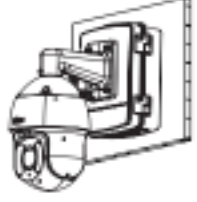
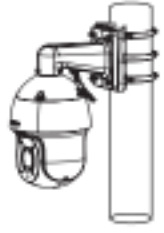
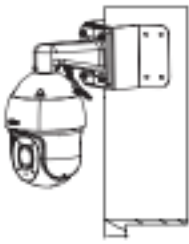
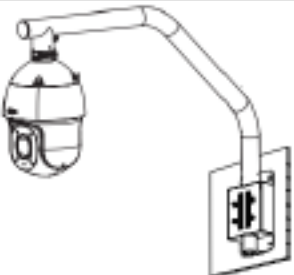

Ceiling Mount INSX111 + INSX300 	Junction Mount INSX305 
Power Box Mount INSX140 + INSX305 	Pole Mount INSX150 + INSX305 
Corner Mount INSX151 + INSX305 	Parapet Mount INSX111 + INSXPARA 



**INSX305
Wall Mount
(Included)**



**INSX120
Junction Box**



**INSX111
Mount Adapter
(Included)**



**INSX150
Pole Mount**



**INSX140
Junction Box**



**INSX151
Corner Mount**



**INSX300
Ceiling Mount**



**INSXPARA
Parapet Mont**



**VUSD256G
Micro SD Card**

*Design and specifications are subjects to change without notice.

